



# PRODUCT INFORMATION SHEET:

## Commercial Flat Retainers

	Part Number	Part	Length	Finish
	2052	Flat 1-1/2" Retainer	24'-6"	Mill
	2047	Flat 2" Retainer	24'-6"	Mill

Aluminum faces

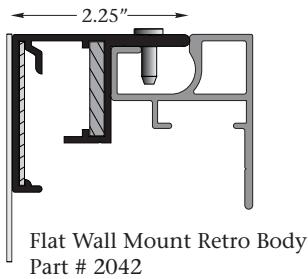

Plastic faces

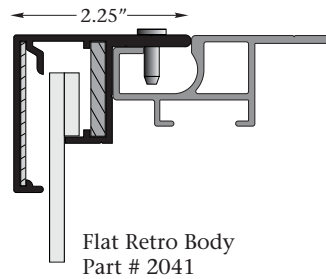

### Hingeable Body Options for 2052 and 2047 retainers:

(All examples shown with part # 2052)

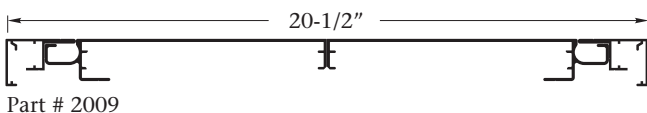
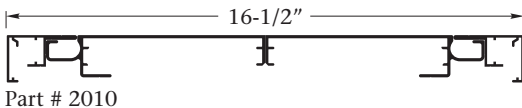
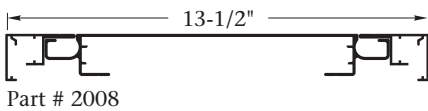
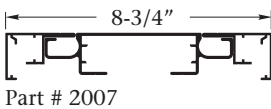
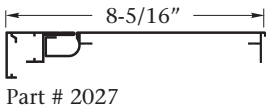
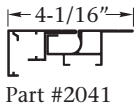
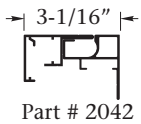

### Features & Benefits

- Delivers a flat, smooth cabinet surface
- Corner key slot provides ease of assembly and added structure
- Allows for a hingeable face to easily access for service
- Can be used with all Commercial Flat Bodies

Shown with Flat Double Face Medium Body  
Part # 2007

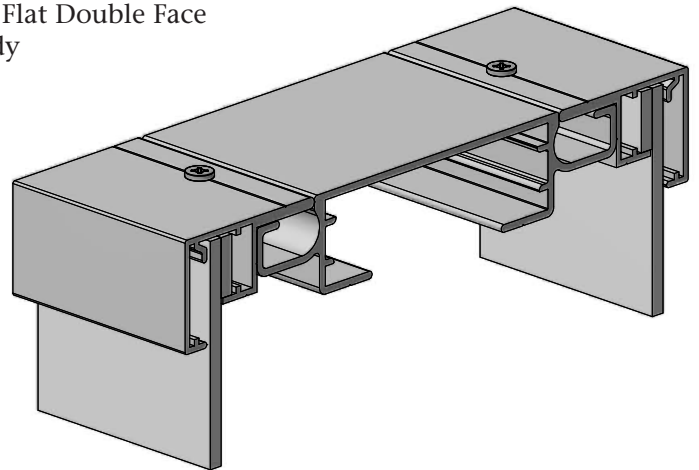



# CONFIGURATIONS

## Commercial Flat Bodies with Flat Bleed Retro Frame II

Flat 2 Piece  
Double Face Body  
#2009

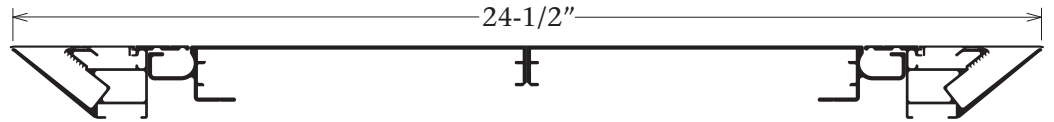

Flat 2 Piece  
Double Face Medium Body  
#2010

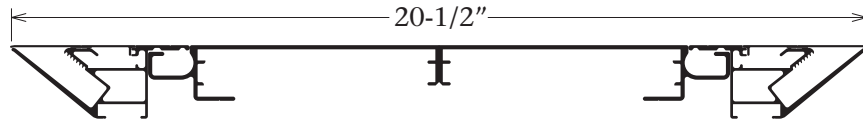

Flat Double Face Body  
#2008

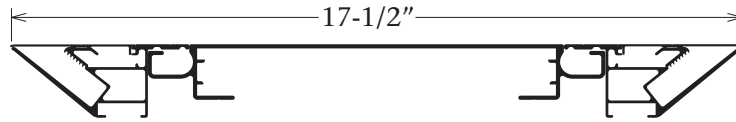

Flat Double Face  
Medium Body  
#2007

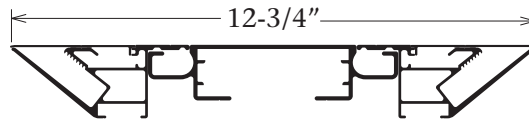

Flat Single Face Body  
#2027

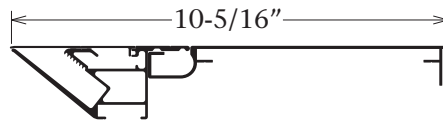

Flat Retro Body  
#2041

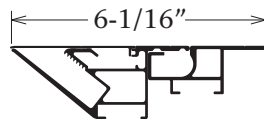

Flat Wall Mount  
Retro Body  
#2042

